

- 技术参数:
- 材料: 压铸铝
 - 盖子材料: PC
 - 表面处理: 粉末喷涂
 - 颜色: RAL 7037 (灰色)
 - 温度范围: -40℃ - +125℃
 - 防护等级: IP65 (联锁状态, IEC 60529)
 - 密封元件: NBR
 - 出线方向: 侧出线
 - 出线孔数: 1
 - 螺纹规格: M25

- Technical specification:
- Material: aluminium die-cast
 - Material,cover: PC
 - Surface: powder-coated
 - Colour: RAL 7037(grey)
 - Temperature range: -40℃ - +125℃
 - Degree of protection: IP65 (acc.to IEC 60529 for coupled connector)
 - Hoods/Housings sealing: NBR
 - Cable entry: side entry
 - No. of cable entries: 1
 - Thread size: M25

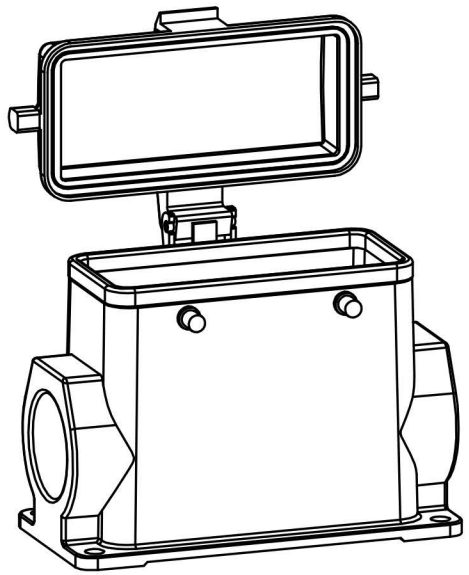

						表面处理 Finish	-			图号 Drawing No.	-
						材料 Material	-			产品代号 Part Code	H16B-SDRH-BO-M25
标记 Mark	次数 Number	变更描述/Description		姓名 Signature	日期 Date	比例 Scale	版本 REV.	重量 Weight	数量 Qty.	产品料号 Part No.	1490160125
绘图 Drawn		18.10.2010	标准化 Stand.	-	-	1:2	V1.0	454g	-	产品名称 Part Name	-
审核 Checked		18.10.2010									
工艺 Process	-	-	批准 Approved		18.10.2010			All Dimensions in mm Original Size DIN A 4		浙江西霸士电气有限公司	