

1 2 3 4 5 6

D
C
B
A

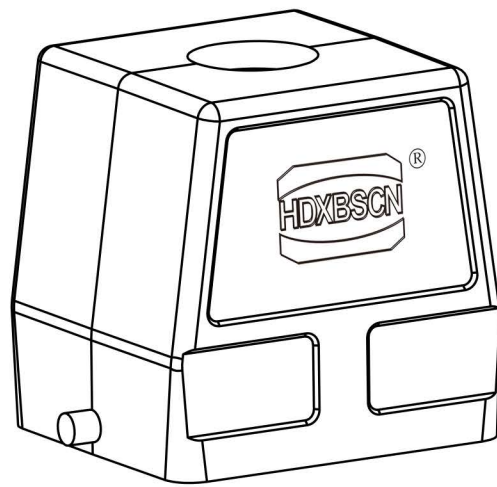
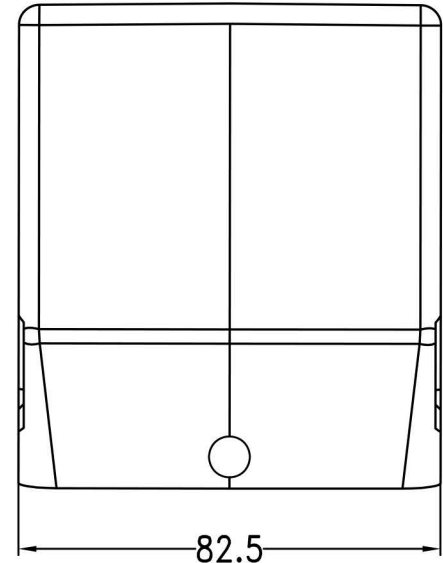
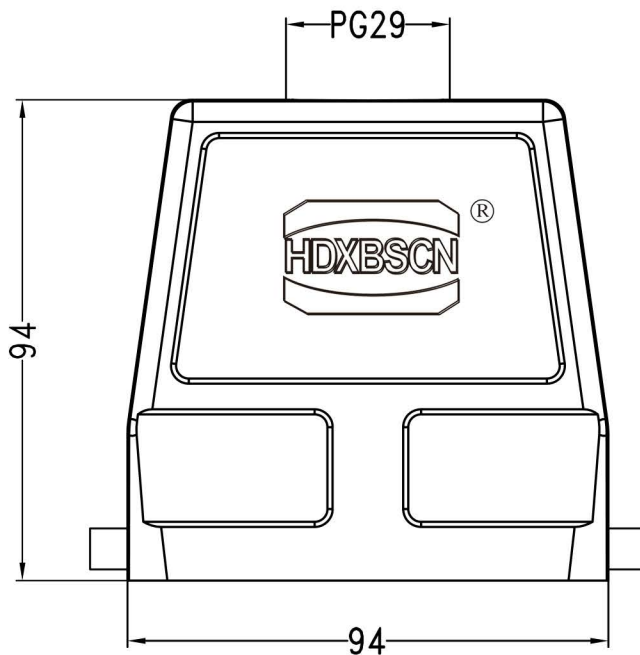

						表面处理 Surface		图号 Drawing No.	
						材料 Material		产品代号 Part Code	
标记 Mark	处数 Number	更改文件号/Changes File No.		签名 Signature	日期 Date			产品料号 Part No.	
姓名/Name		日期/Date		姓名/Name		日期/Date		1320320129	
绘图 Drawn			标准化 Stand.			比例 Scale	版本 REV.	重量 Weight	数量 Qty.
审核 Checked									产品名称 Part Name
工艺 Process			批准 Approved						
								All Dimensions in mm Original Size DIN A 4	
								浙江西霸士电气有限公司	

1 2 3 4 5 6